

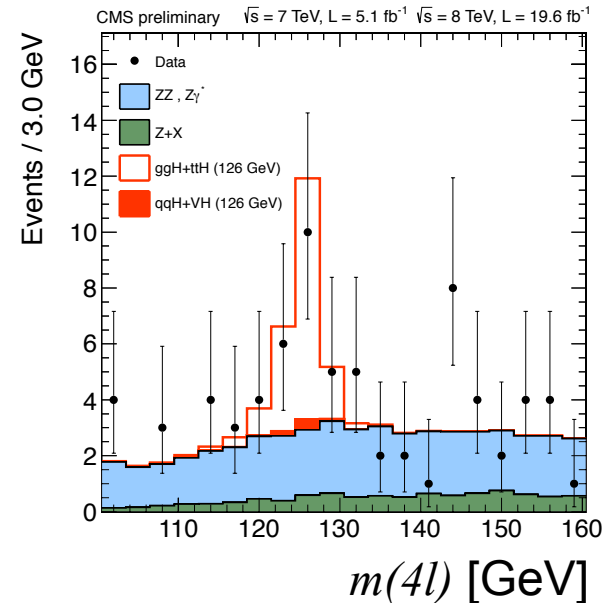

<http://cern.ch/Gfitter>

EPJC 72, 2205 (2012), arXiv:1209.2716

The ElectroWeak fit of Standard Model after the Discovery of the Higgs-like boson

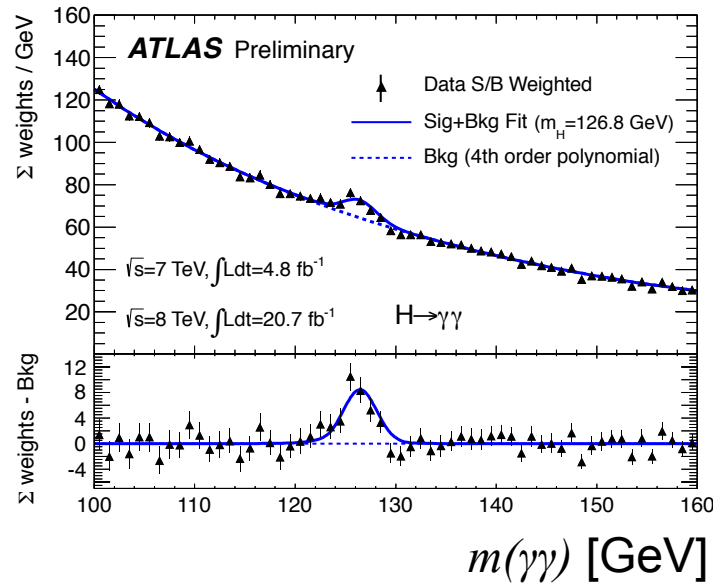

(*) M. Baak, J. Haller, A. Höcker, R. Kogler, K. Mönig, M. Schott, J. Stelzer

Reminder: the predictive power of the SM

Tree level relations for $Z \rightarrow f\bar{f}$

- $i\bar{f}\gamma^\mu (g_{V,f} - g_{A,f}\gamma_5) f Z_\mu$
- Unification connects the electromagnetic and weak couplings
- E.g. M_W can be expressed as function of M_Z and G_F

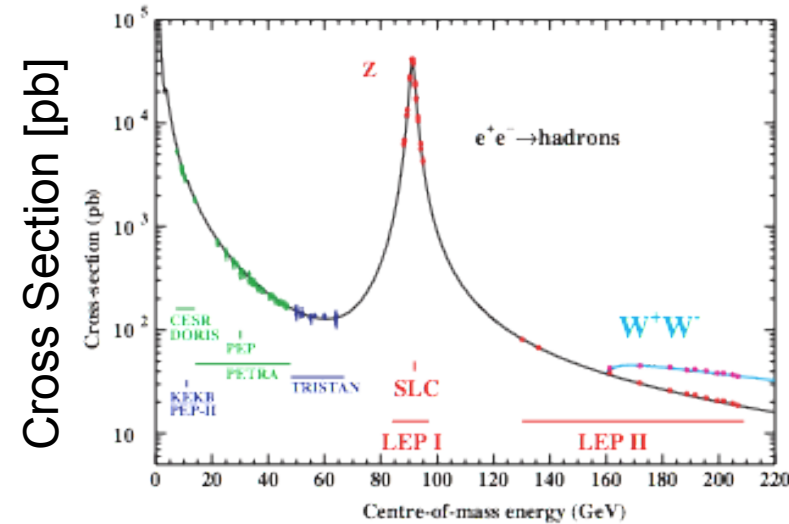
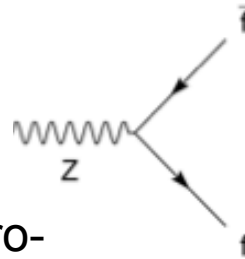

\sqrt{s} [GeV]

The impact of radiative corrections

- Absorbed into EW form factors:
 ρ , κ , Δr
- Effective couplings at the Z-pole
- Quadratically dependent on m_t ,
logarithmic dependence on M_H

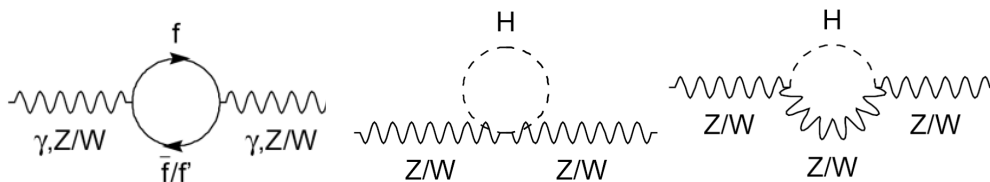

$$g_{V,f} = \sqrt{\rho_Z^f} \left(I_3^f - 2Q^f \sin^2 \theta_{\text{eff}}^f \right)$$

$$g_{A,f} = \sqrt{\rho_Z^f} I_3^f$$

$$\sin^2 \theta_{\text{eff}}^f = \kappa_Z^f \sin^2 \theta_W$$

$$M_W^2 = \frac{M_Z^2}{2} \left(1 + \sqrt{1 - \frac{\sqrt{8}\pi\alpha(1 + \Delta r)}{G_F M_Z^2}} \right)$$

Global EW fits: a long tradition



EW fits: a long tradition

- Huge amount of pioneering work by many!
- Precision measurements crucial, first from LEP/SLC, then Tevatron and now LHC.
- Precise understanding of loop corrections essential.
 - Observables known at least at two-loop order, sometimes more.

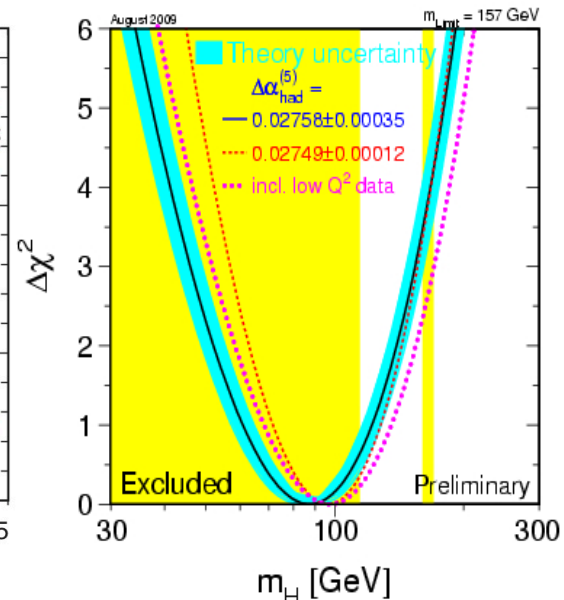
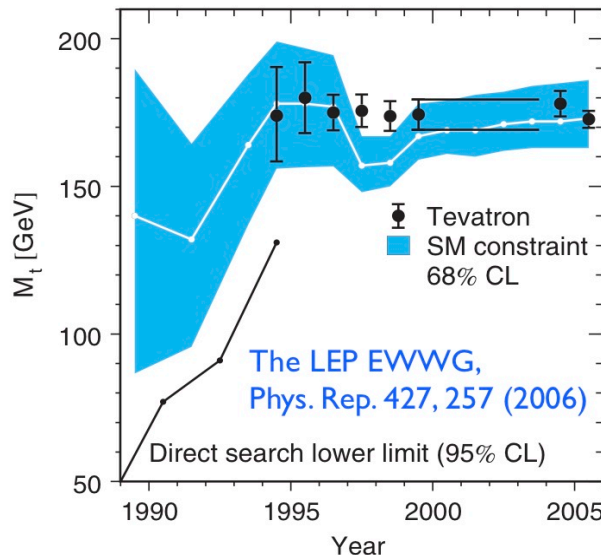

Hunt for the Higgs

- M_H last missing input parameter
- Indirect determination from EW fit (2012): $M_H = 96^{+31}_{-24}$ GeV
- (Direct exclusion limits also incorporated in EW fits.)

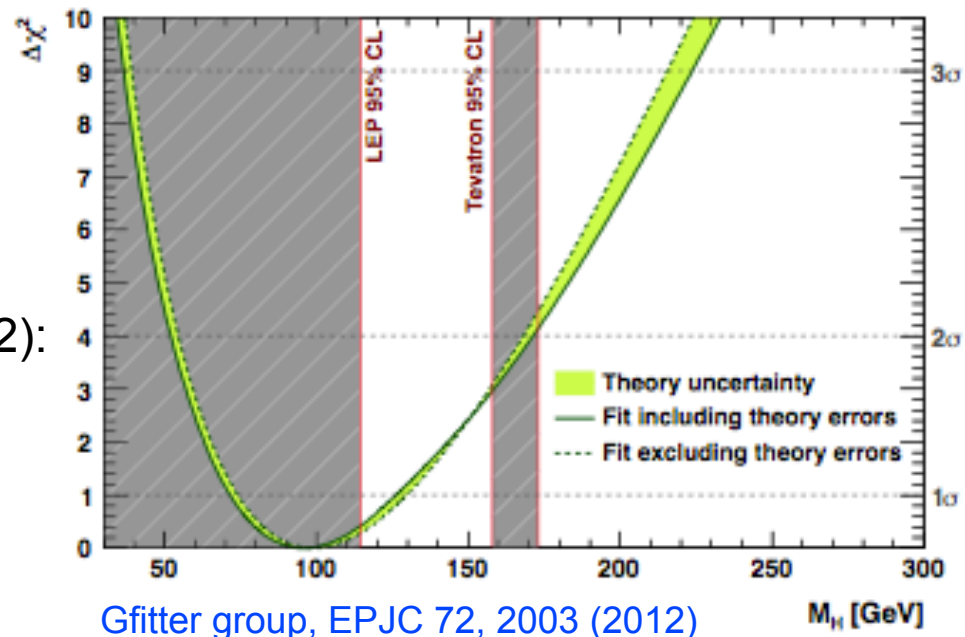

Gfitter group, EPJC 72, 2003 (2012)

The SM fit with Gfitter, including the Higgs



Discovery of Higgs-like boson by LHC

- Cross section and branching ratios so far ~compatible with SM Higgs boson
- **This talk: assume boson is SM Higgs.**
- Use in EW fit: $M_H = 125.7 \pm 0.4 \text{ GeV}$
- Change between fully uncorrelated and fully correlated systematic uncertainties is minor: $\delta M_H : 0.4 \rightarrow 0.5 \text{ GeV}$

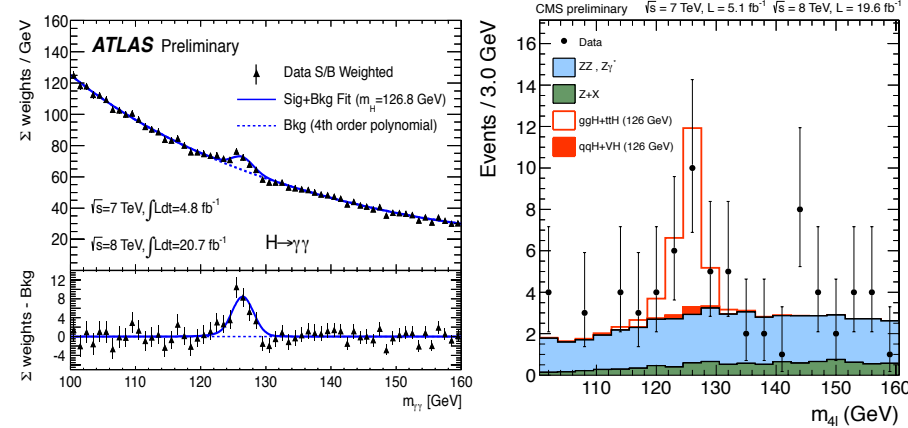

For first time SM is fully over-constrained → test its self-consistency!

In EW fit with Gfitter we use state-of-the-art calculations:

- M_W Mass of the W boson [M. Awramik et al., Phys. Rev. D69, 053006 (2004)]
- Γ_Z, Γ_W Partial and total widths of the Z and W [Cho et. al, arXiv:1104.1769]
- $\sin^2 \theta_{\text{eff}}$ Effective weak mixing angle [M. Awramik et al., JHEP 11, 048 (2006), M. Awramik et al., Nucl.Phys.B813:174-187 (2009)]
- Γ_{had} QCD Adler functions at N3LO [P. A. Baikov et al., PRL108, 222003 (2012)]
- R_b Partial width of $Z \rightarrow b\bar{b}$ [Freitas et al., JHEP08, 050 (2012)] **← New! full 2-loop calc.**

- Latest experimental inputs:
 - **Z-pole observables**: from LEP / SLC
[ADLO+SLD, Phys. Rept. 427, 257 (2006)]
 - **M_W and Γ_W** from LEP/Tevatron
[arXiv:1204.1069]
 - **m_{top}** : average from Tevatron
[arXiv:1207.1069]
 - **m_c, m_b** world averages
[PDG, J. Phys. G33,1 (2006)]
 - **$\Delta\alpha_{\text{had}}^{(5)}(M_Z^2)$** including α_S dependency
[Davier et al., EPJC 71, 1515 (2011)]
 - **M_H** from LHC
[arXiv:1207.7214, arXiv:1207.7235]
- 7 free fit parameters:
 - $M_Z, M_H, \alpha_S(M_Z^2), \Delta\alpha_{\text{had}}^{(5)}(M_Z^2), m_t, \bar{m}_c, \bar{m}_b$
 - Two nuisance parameters for theoretical uncertainties:
 $\delta M_W (4 \text{ MeV}), \delta \sin^2\theta_{\text{eff}}^l (4.7 \times 10^{-5})$

M_H [GeV] ^(o)	125.7 ± 0.4	LHC
M_W [GeV]	80.385 ± 0.015	Tevatron
Γ_W [GeV]	2.085 ± 0.042	
M_Z [GeV]	91.1875 ± 0.0021	LHC
Γ_Z [GeV]	2.4952 ± 0.0023	
σ_{had}^0 [nb]	41.540 ± 0.037	
R_ℓ^0	20.767 ± 0.025	SLC
$A_{\text{FB}}^{0,\ell}$	0.0171 ± 0.0010	
$A_\ell^{(*)}$	0.1499 ± 0.0018	SLC
$\sin^2\theta_{\text{eff}}^\ell(Q_{\text{FB}})$	0.2324 ± 0.0012	
A_c	0.670 ± 0.027	SLC
A_b	0.923 ± 0.020	
$A_{\text{FB}}^{0,c}$	0.0707 ± 0.0035	LEP
$A_{\text{FB}}^{0,b}$	0.0992 ± 0.0016	
R_c^0	0.1721 ± 0.0030	Tevatron
R_b^0	0.21629 ± 0.00066	
\bar{m}_c [GeV]	$1.27^{+0.07}_{-0.11}$	Tevatron
\bar{m}_b [GeV]	$4.20^{+0.17}_{-0.07}$	
m_t [GeV]	173.18 ± 0.94	
$\Delta\alpha_{\text{had}}^{(5)}(M_Z^2) (\Delta\nabla)$	2757 ± 10	

Electroweak Fit – SM Fit Results



- From the Gfitter Group, EPJC 72, 2205 (2012)

- Left: full fit incl. M_H

- Middle: fit not incl. M_H

- Right: fit incl M_H , not the row

Parameter	Input value	Free in fit	Fit result incl. M_H	Fit result not incl. M_H	Fit result incl. M_H but not exp. input in row
M_H [GeV] ^(o)	125.7 ± 0.4	yes	125.7 ± 0.4	94^{+25}_{-22}	94^{+25}_{-22}
M_W [GeV]	80.385 ± 0.015	–	80.367 ± 0.007	80.380 ± 0.012	80.359 ± 0.011
Γ_W [GeV]	2.085 ± 0.042	–	2.091 ± 0.001	2.092 ± 0.001	2.091 ± 0.001
M_Z [GeV]	91.1875 ± 0.0021	yes	91.1878 ± 0.0021	91.1874 ± 0.0021	91.1983 ± 0.0116
Γ_Z [GeV]	2.4952 ± 0.0023	–	2.4954 ± 0.0014	2.4958 ± 0.0015	2.4951 ± 0.0017
σ_{had}^0 [nb]	41.540 ± 0.037	–	41.479 ± 0.014	41.478 ± 0.014	41.470 ± 0.015
R_ℓ^0	20.767 ± 0.025	–	20.740 ± 0.017	20.743 ± 0.018	20.716 ± 0.026
$A_{\text{FB}}^{0,\ell}$	0.0171 ± 0.0010	–	0.01627 ± 0.0002	0.01637 ± 0.0002	0.01624 ± 0.0002
A_ℓ (*)	0.1499 ± 0.0018	–	$0.1473^{+0.0006}_{-0.0008}$	0.1477 ± 0.0009	0.1468 ± 0.0005 ^(†)
$\sin^2\theta_{\text{eff}}^\ell(Q_{\text{FB}})$	0.2324 ± 0.0012	–	$0.23148^{+0.00011}_{-0.00007}$	$0.23143^{+0.00010}_{-0.00012}$	0.23150 ± 0.00009
A_c	0.670 ± 0.027	–	$0.6680^{+0.00025}_{-0.00038}$	$0.6682^{+0.00042}_{-0.00035}$	0.6680 ± 0.00031
A_b	0.923 ± 0.020	–	$0.93464^{+0.00004}_{-0.00007}$	0.93468 ± 0.00008	0.93463 ± 0.00006
$A_{\text{FB}}^{0,c}$	0.0707 ± 0.0035	–	$0.0739^{+0.0003}_{-0.0005}$	0.0740 ± 0.0005	0.0738 ± 0.0004
$A_{\text{FB}}^{0,b}$	0.0992 ± 0.0016	–	$0.1032^{+0.0004}_{-0.0006}$	0.1036 ± 0.0007	0.1034 ± 0.0004
R_c^0	0.1721 ± 0.0030	–	0.17223 ± 0.00006	0.17223 ± 0.00006	0.17223 ± 0.00006
R_b^0	0.21629 ± 0.00066	–	0.21474 ± 0.00003	0.21475 ± 0.00003	0.21473 ± 0.00003
\overline{m}_c [GeV]	$1.27^{+0.07}_{-0.11}$	yes	$1.27^{+0.07}_{-0.11}$	$1.27^{+0.07}_{-0.11}$	–
\overline{m}_b [GeV]	$4.20^{+0.17}_{-0.07}$	yes	$4.20^{+0.17}_{-0.07}$	$4.20^{+0.17}_{-0.07}$	–
m_t [GeV]	173.18 ± 0.94	yes	173.52 ± 0.88	173.14 ± 0.93	$175.8^{+2.7}_{-2.4}$
$\Delta\alpha_{\text{had}}^{(5)}(M_Z^2)$ ($\Delta\nabla$)	2757 ± 10	yes	2755 ± 11	2757 ± 11	2716^{+49}_{-43}
$\alpha_s(M_Z^2)$	–	yes	0.1191 ± 0.0028	0.1192 ± 0.0028	0.1191 ± 0.0028
$\delta_{\text{th}} M_W$ [MeV]	$[-4, 4]_{\text{theo}}$	yes	4	4	–
$\delta_{\text{th}} \sin^2\theta_{\text{eff}}^\ell$ (Δ)	$[-4.7, 4.7]_{\text{theo}}$	yes	–1.4	4.7	–

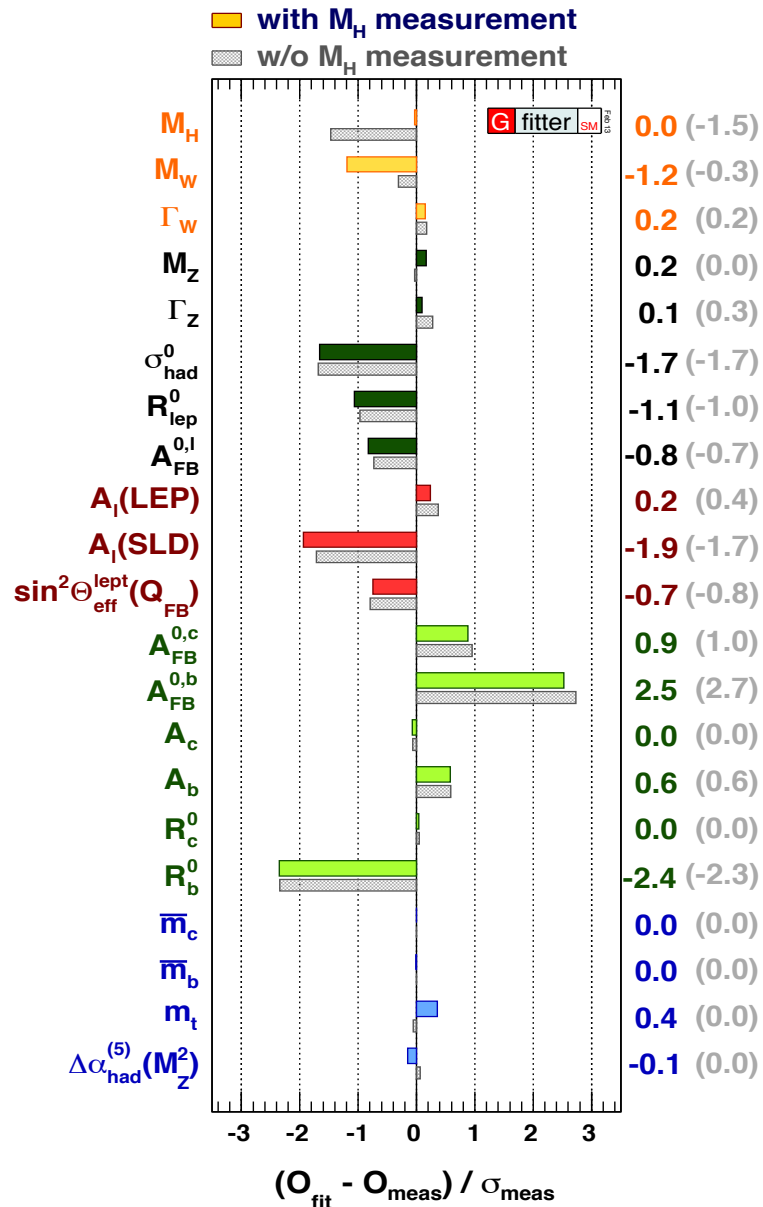

Plot inspired by Eberhardt et al. [arXiv:1209.1101]

- Pull values of full fit (with M_H)**
 - No individual value exceeds 3σ
 - Small pulls for M_H , M_Z , $\Delta\alpha_{had}^{(5)}(M_Z^2)$, \bar{m}_c , \bar{m}_b indicate that input accuracies exceed fit requirements
 - Largest deviations in b-sector: $A_{FB}^{0,b}$ and R_b^0 with 2.5σ and -2.4σ \rightarrow largest contribution to χ^2
 - R_b^0 using one-loop calculation -0.8σ
 - R_b^0 has only little dependence on M_H
- Goodness of fit – p-value:**
 - $\chi^2_{min} = 21.8 \rightarrow \text{Prob}(\chi^2_{min}, 14) = 8\%$
 - From pseudo experiments: $7 \pm 1\%$**
 - Large value of χ^2_{min} not due to inclusion of M_H measurement.
 - Without M_H measurement: $\chi^2_{min} = 20.3 \rightarrow \text{Prob}(\chi^2_{min}, 13) = 9\%$

- Scan of $\Delta\chi^2$ profile versus M_H
 - Grey band: fit w/o M_H measurement
 - Blue line: full SM fit, with M_H meas.
 - Fit w/o M_H measurement gives:
 $M_H = 94^{+25}_{-22}$ GeV
 - Consistent at 1.3σ with LHC measurement.

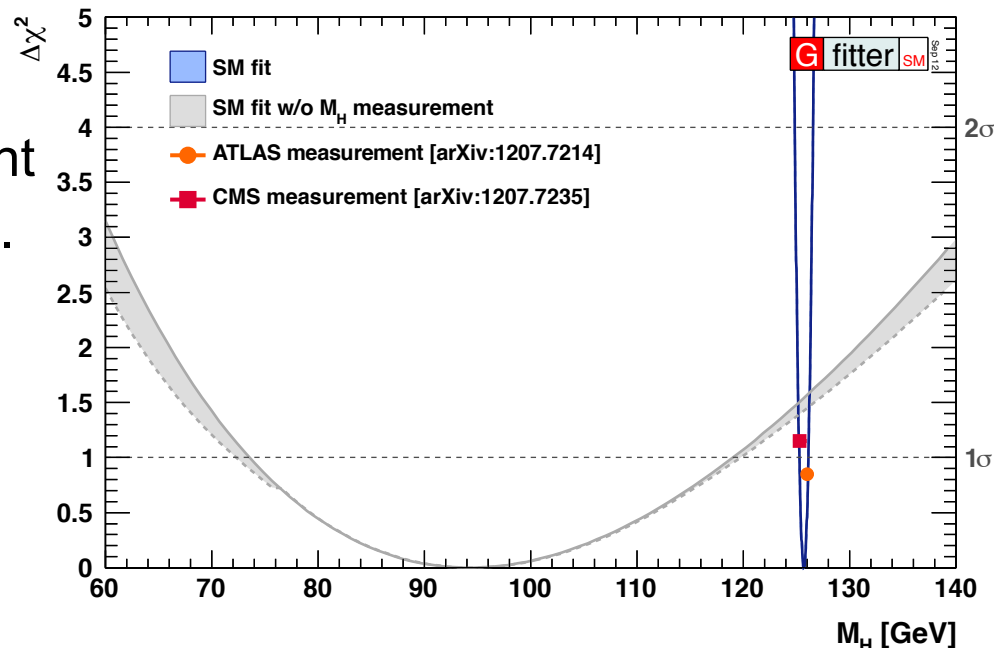

- Bottom plot: impact of other most sensitive Higgs observables

- Determination of M_H removing all sensitive observables except the given one.
- Known tension (2.5σ) between $A_1(\text{SLD})$, $A_{\text{FB}}^{0,b}$, and M_W clearly visible.

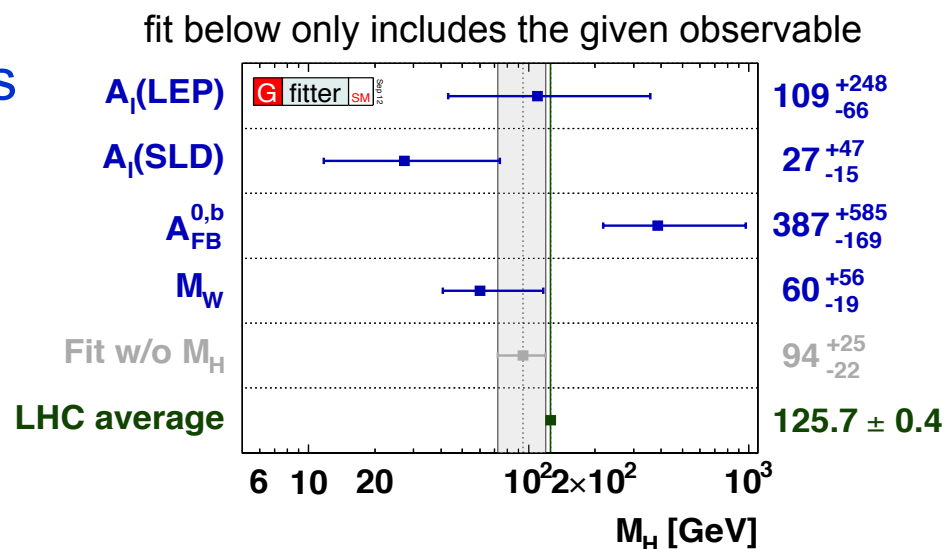

- Scan of $\Delta\chi^2$ profile versus M_W
 - Also shown: SM fit with minimal inputs: M_Z , G_F , $\Delta\alpha_{\text{had}}^{(5)}(M_Z)$, $\alpha_s(M_Z)$, M_H , and fermion masses
 - Good consistency between total fit and SM w/ minimal inputs
- M_H measurement allows for precise constraint on M_W
 - Agreement at 1.4σ
- Fit result for indirect determination of M_W (full fit w/o M_W):

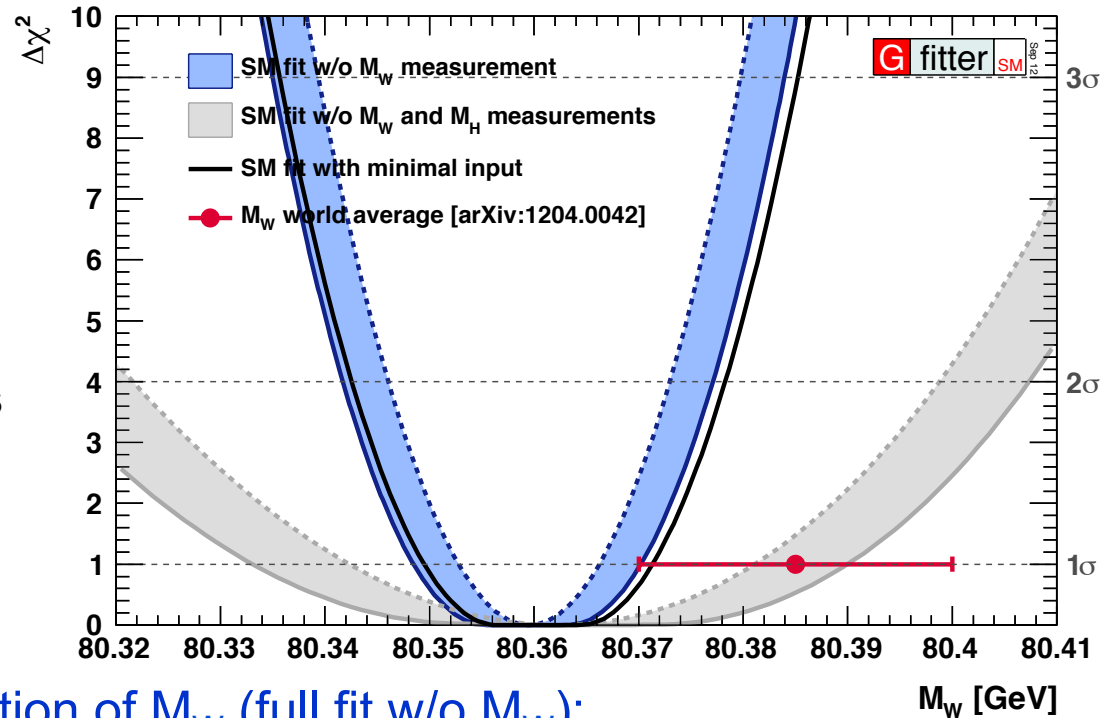

$$\begin{aligned}
 M_W &= 80.3593 \pm 0.0056_{m_t} \pm 0.0026_{M_Z} \pm 0.0018_{\Delta\alpha_{\text{had}}} \\
 &\quad \pm 0.0017_{\alpha_s} \pm 0.0002_{M_H} \pm 0.0040_{\text{theo}} \\
 &= 80.359 \pm 0.011_{\text{tot}} ,
 \end{aligned}$$

- More precise estimate of M_W than the direct measurements!
- Uncertainty on world average measurement: 15 MeV

Indirect effective weak mixing angle

- Right: scan of $\Delta\chi^2$ profile versus $\sin^2\theta_{\text{eff}}^l$
 - All sensitive measurements removed from the SM fit.
 - Also shown: SM fit with minimal inputs

- M_H measurement allows for very precise constraint on $\sin^2\theta_{\text{eff}}^l$

- Fit result for indirect determination of $\sin^2\theta_{\text{eff}}^l$:

$$\begin{aligned} \sin^2\theta_{\text{eff}}^l &= 0.231496 \pm 0.000030_{m_t} \pm 0.000015_{M_Z} \pm 0.000035_{\Delta\alpha_{\text{had}}} \\ &\quad \pm 0.000010_{\alpha_S} \pm 0.000002_{M_H} \pm 0.000047_{\text{theo}} , \\ &= 0.23150 \pm 0.00010_{\text{tot}} , \end{aligned}$$

- More precise than direct determination (from LEP/SLD) !

- Uncertainty on LEP/SLD average: 1.6×10^{-4}

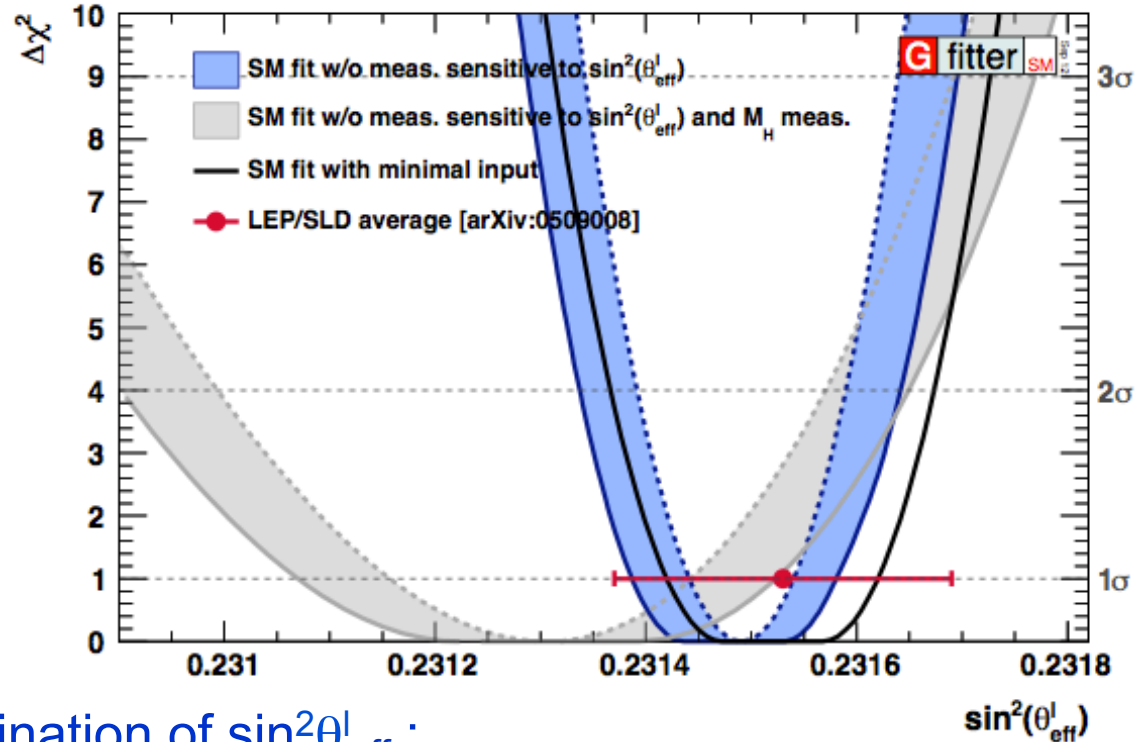

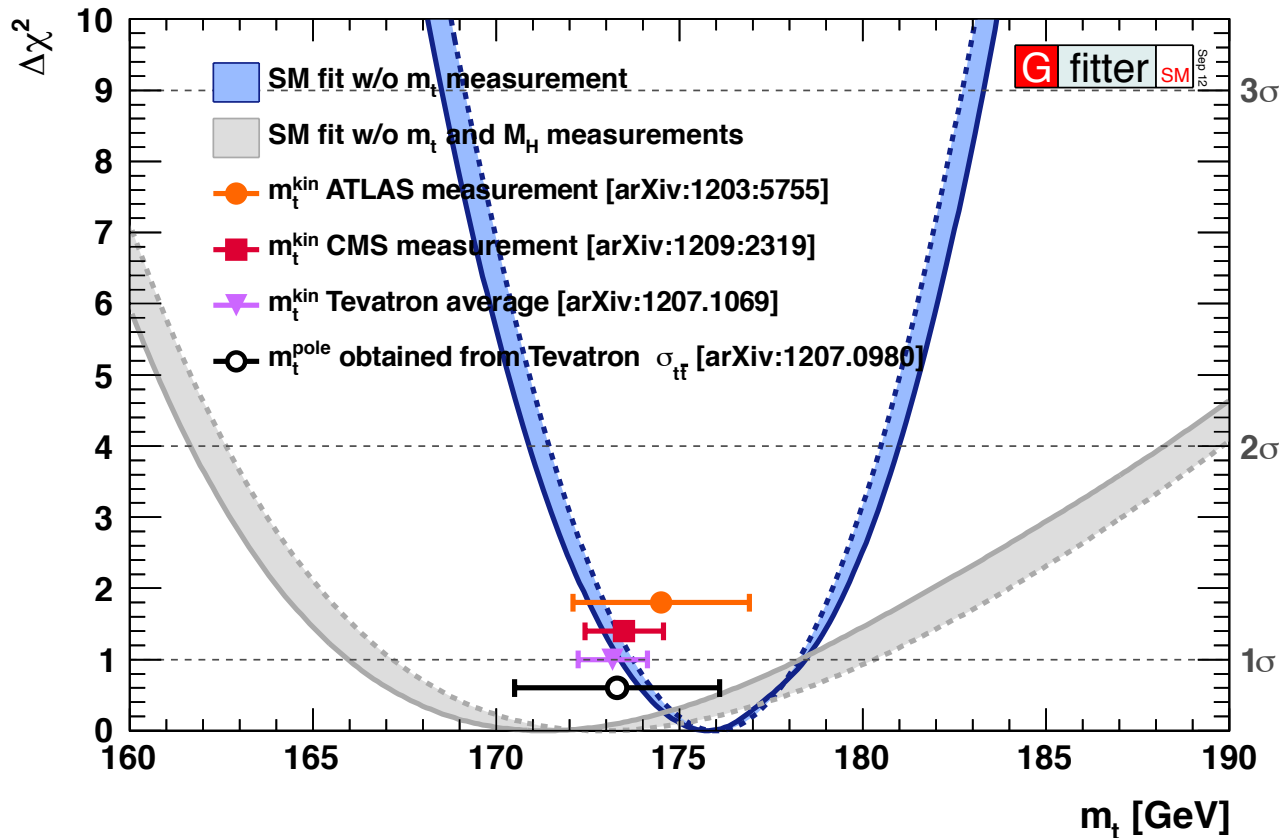

- Shown: scan of $\Delta\chi^2$ profile versus m_t (without m_t measurement)
 - M_H measurement allows for significant better constraint of m_t
 - Indirect determination consistent with direct measurements
 - Indirect result: $m_t = 175.8^{+2.7}_{-2.4}$ GeV (Tevatron average: 173.2 ± 0.9 GeV)

State of the SM: W versus top mass

- Scan of M_W vs m_t , with the direct measurements excluded from the fit.
- Results from Higgs measurement significantly reduces allowed indirect parameter space → corners the SM!

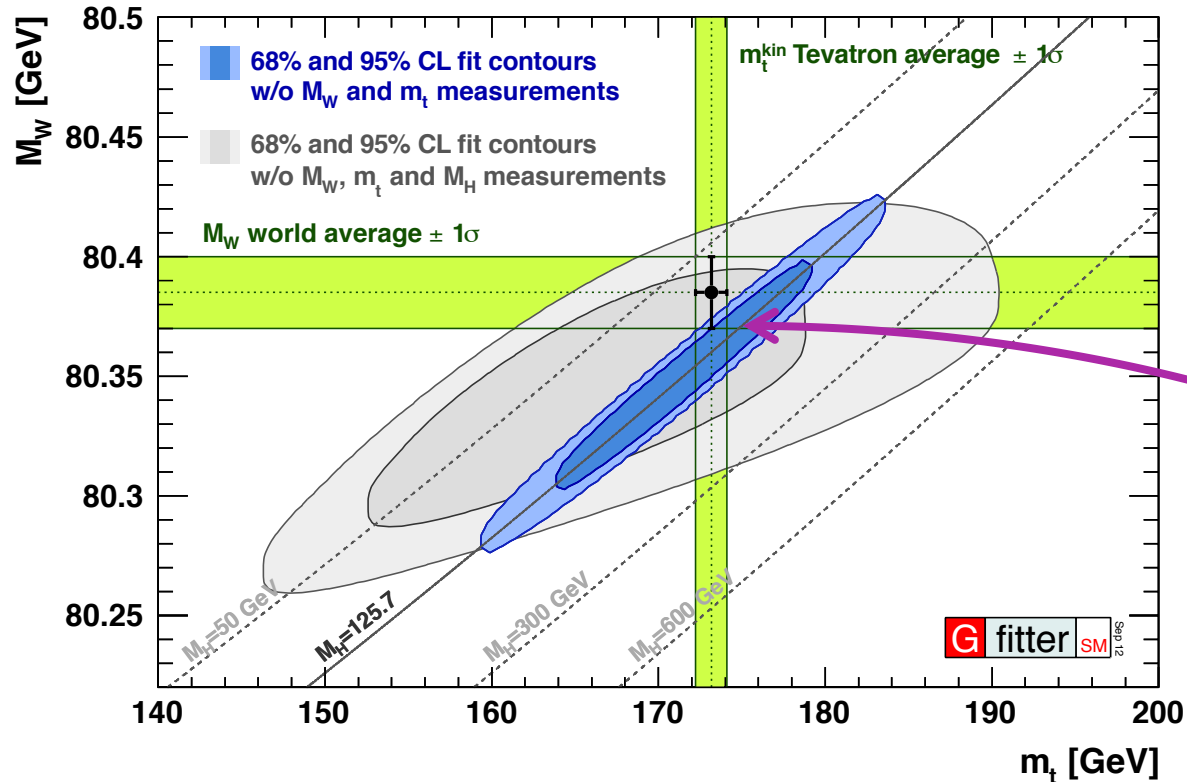

- Observed agreement demonstrates impressive consistency of the SM!

Constraints on S, T, U

- Electroweak fit sensitive to BSM physics through vacuum polarization corrections (also absorbed in ρ , κ , Δr).
- Described with STU parametrization [Peskin and Takeuchi, Phys. Rev. D46, 1 (1991)]
- SM: $M_H = 125.7 \text{ GeV}$, $m_t = 173.2 \text{ GeV}$
 - This defines $(S, T, U) = (0, 0, 0)$
- S, T depend logarithmically on M_H

Fit result:

$$S = 0.03 \pm 0.10$$

$$T = 0.05 \pm 0.12$$

$$U = 0.03 \pm 0.10$$

	S	T	U
S	1	+0.89	-0.54
T		1	-0.83
U			1

- Stronger constraints from fit with $U=0$
- No indication for new physics.
- Can now use this constrain 4th gen, Ex-Dim, T-C, Higgs couplings, etc.

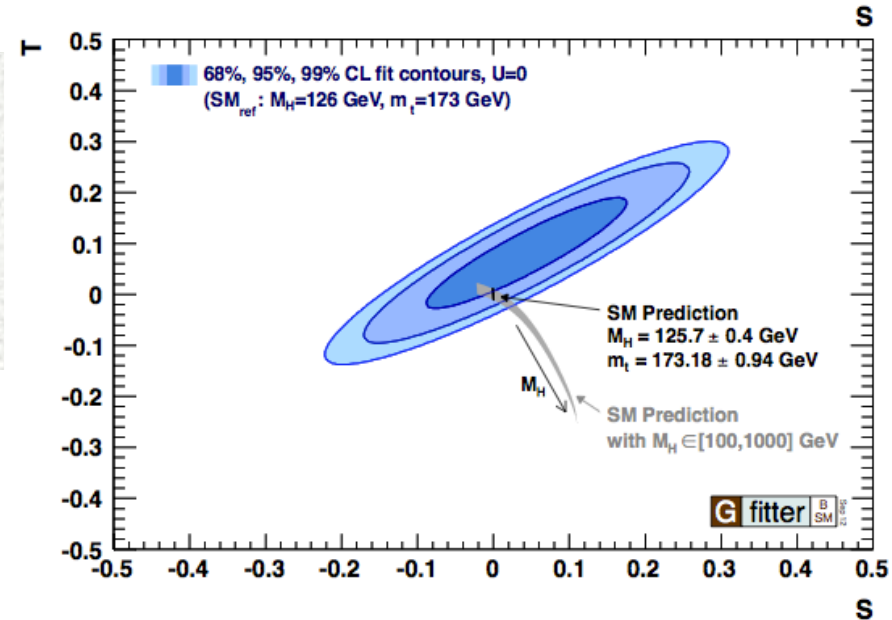
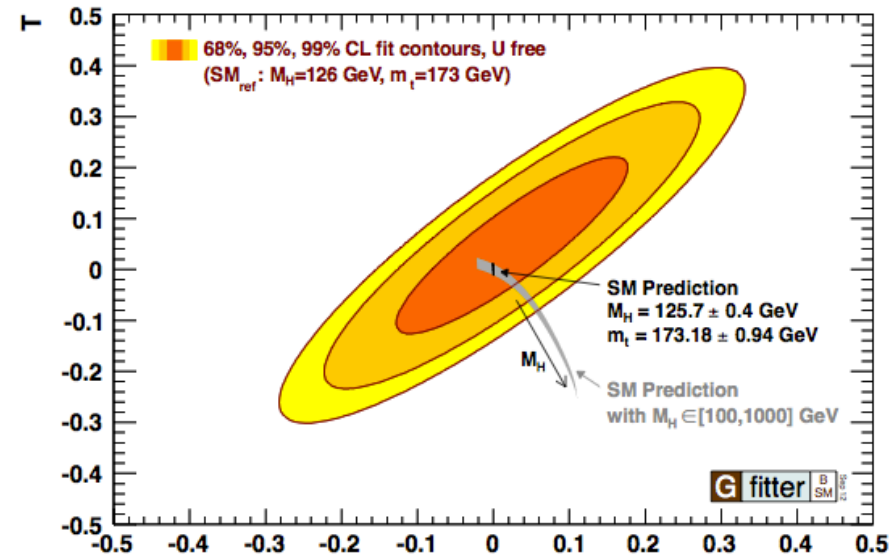

- Future Linear Collider could improve precision of EW observables tremendously.
 - *WW threshold, to obtain M_W*
 - from threshold scan: $\delta M_W : 15 \rightarrow 6 \text{ MeV}$
 - *ttbar threshold, to obtain m_t*
 - obtain m_t indirectly from production cross section: $\delta m_t : 0.9 \rightarrow 0.1 \text{ GeV}$
 - *Z pole measurements*
 - High statistics: 10^9 Z decays: $\delta R_{\text{lep}}^0 : 2.5 \cdot 10^{-2} \rightarrow 4 \cdot 10^{-3}$
 - With polarized beams, uncertainty on $\delta A_{\text{LR}}^{0,\text{f}} : 10^{-3} \rightarrow 10^{-4}$, which translates to $\delta \sin^2 \theta_{\text{eff}}^l : 1.6 \cdot 10^{-4} \rightarrow 1.3 \cdot 10^{-5}$

- Low-energy data results
 - *For $\Delta \alpha_{\text{had}}$:*
 - more precise e^+e^- cross section results for low energy ($\sqrt{s} < 1.8 \text{ GeV}$) and around cc resonance (KLOE-II, BaBar-ISR, BES-III), improved α_s , improvements in theory: $\Delta \alpha_{\text{had}} : 10^{-4} \rightarrow 5 \cdot 10^{-5}$

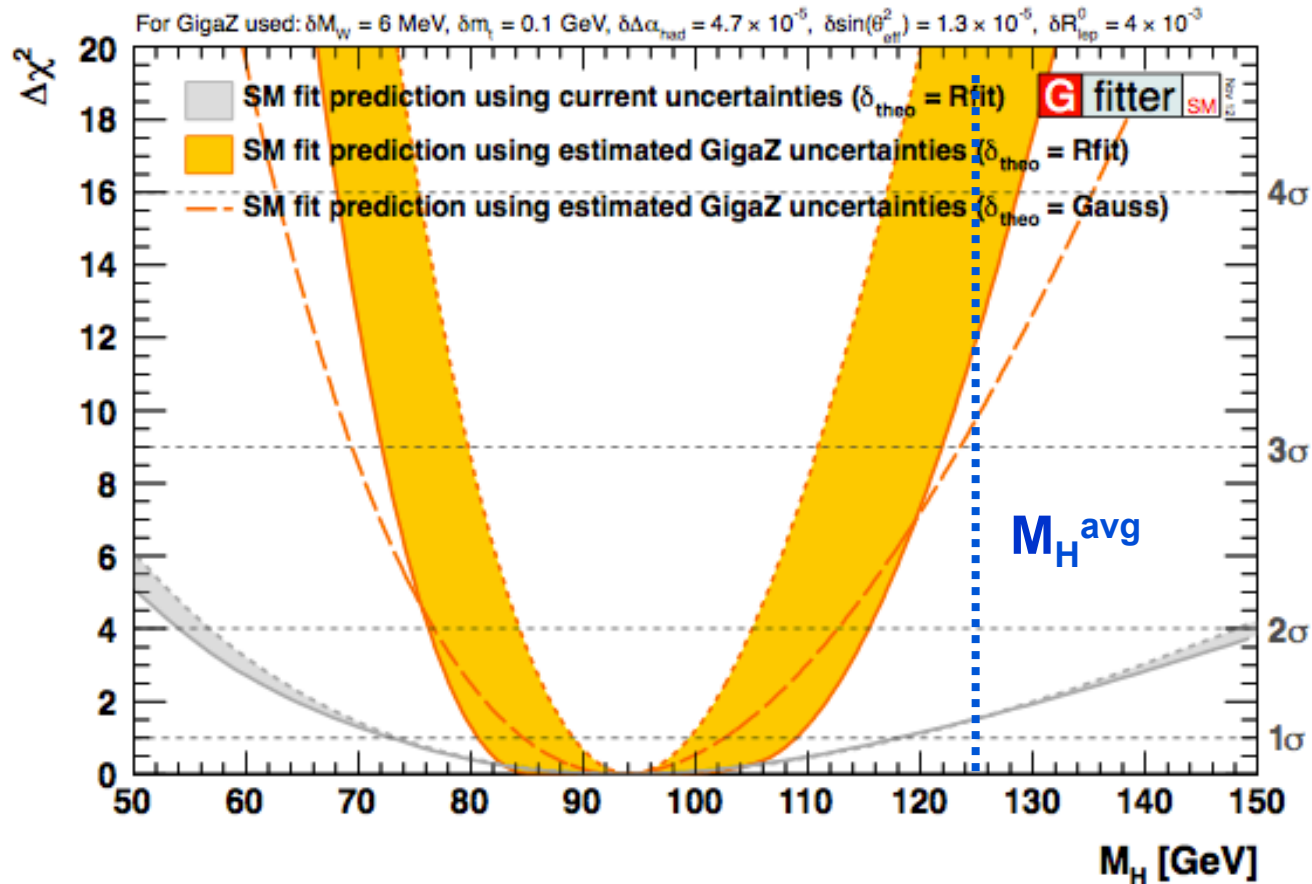

- Logarithmic dependency on $M_H \rightarrow$ cannot compete with direct M_H meas.
- Indirect prediction M_H dominated by theory uncertainties.
 - No theory uncertainty: $M_H = 94.2^{+5.3}_{-5.0} \text{ GeV}$
 - Rfit scheme: $M_H = 92.3^{+16.6}_{-11.6} \text{ GeV}$

Prospects for ILC with Giga Z

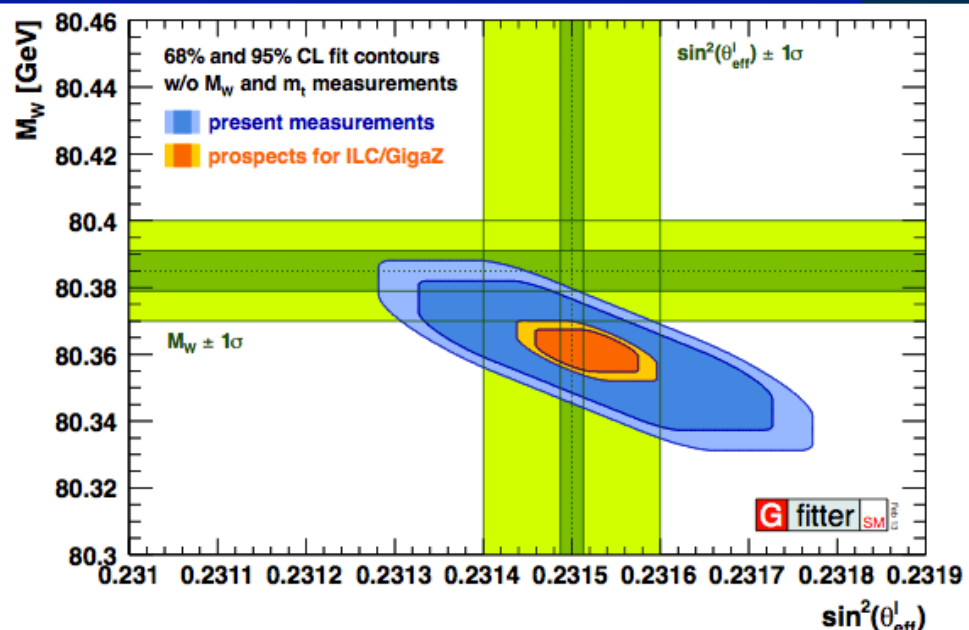
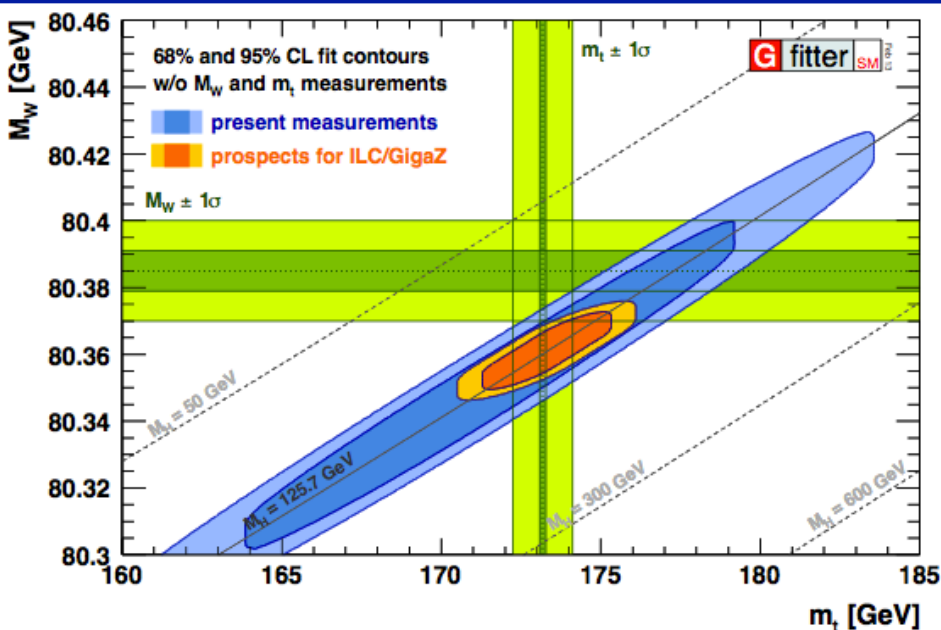

- current precision
- prospects for direct ILC measurements

- *Assuming also 50% of today's theoretical uncertainties*
- Implies three-loop EW calculations!
- Huge reduction of uncertainty on indirect determinations
- Also strong constraints on S, T, U

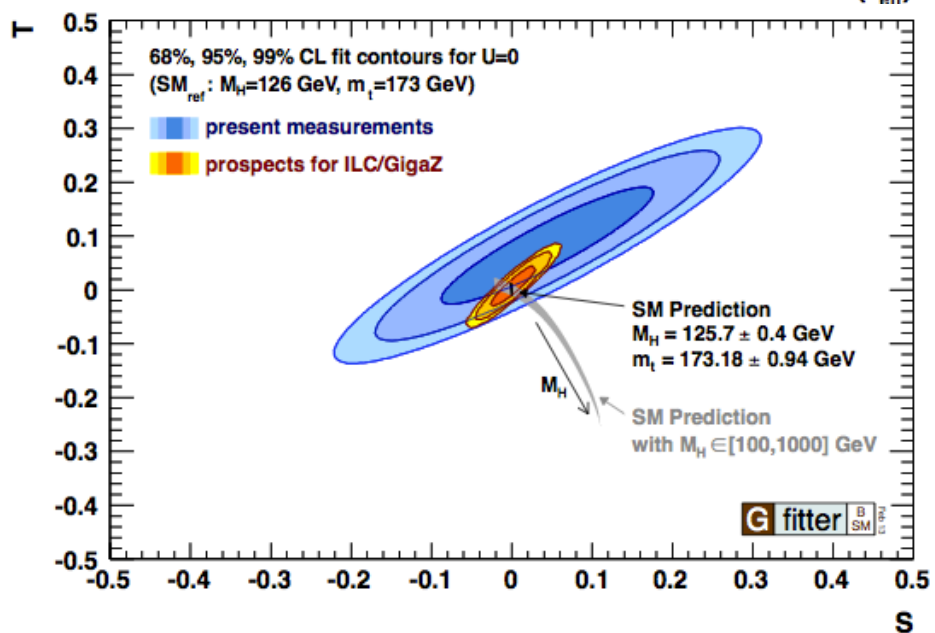

- Including M_H measurement, for first time SM is fully over-constrained!
 - M_H consistent at 1.3σ with indirect prediction from EW fit.
- p-Value of global electroweak fit of SM: 7% (pseudo-experiments)
 - Would be great to revisit $Z \rightarrow b\bar{b}$, both theoretically and experimentally
- Knowledge of M_H dramatically improves SM prediction of key observables
 - M_W ($28 \rightarrow 11$ MeV), $\sin^2\theta_{\text{eff}}^l$ ($2.3 \times 10^{-5} \rightarrow 1.0 \times 10^{-5}$), m_t ($6.2 \rightarrow 2.5$ GeV)
- Improved accuracies set benchmark for new direct measurements!

- δM_W (indirect) = 11 MeV
 - Large contributions to δM_W (and $\delta \sin^2\theta_{\text{eff}}^l$) from top and unknown higher-order EW corrections

- δM_W (direct) = 15 MeV

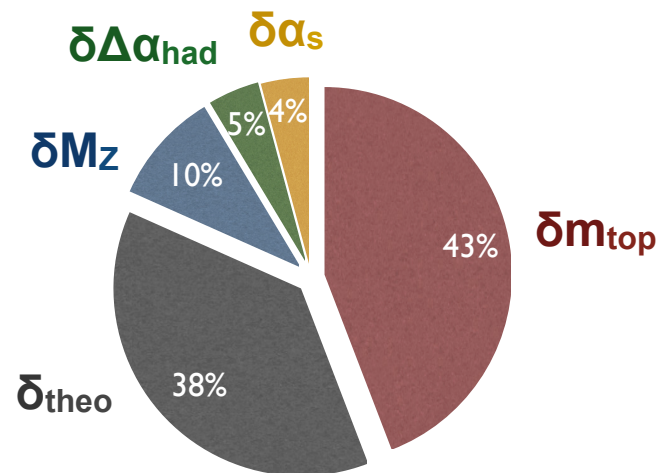

- Latest results always available at: <http://cern.ch/Gfitter>
 - Results in this presentation: EPJC 72, 2205 (2012)



A **G**eneric **Fitter** Project for HEP Model Testing

Backup

- Toy analysis with 20k pseudo experiments
 - p-value = probability of getting $\chi^2_{\min, \text{toy}}$ larger than χ^2_{\min} from data
 - i.e probability of incorrectly rejecting the SM as false = 0.07 ± 0.01 (theo)

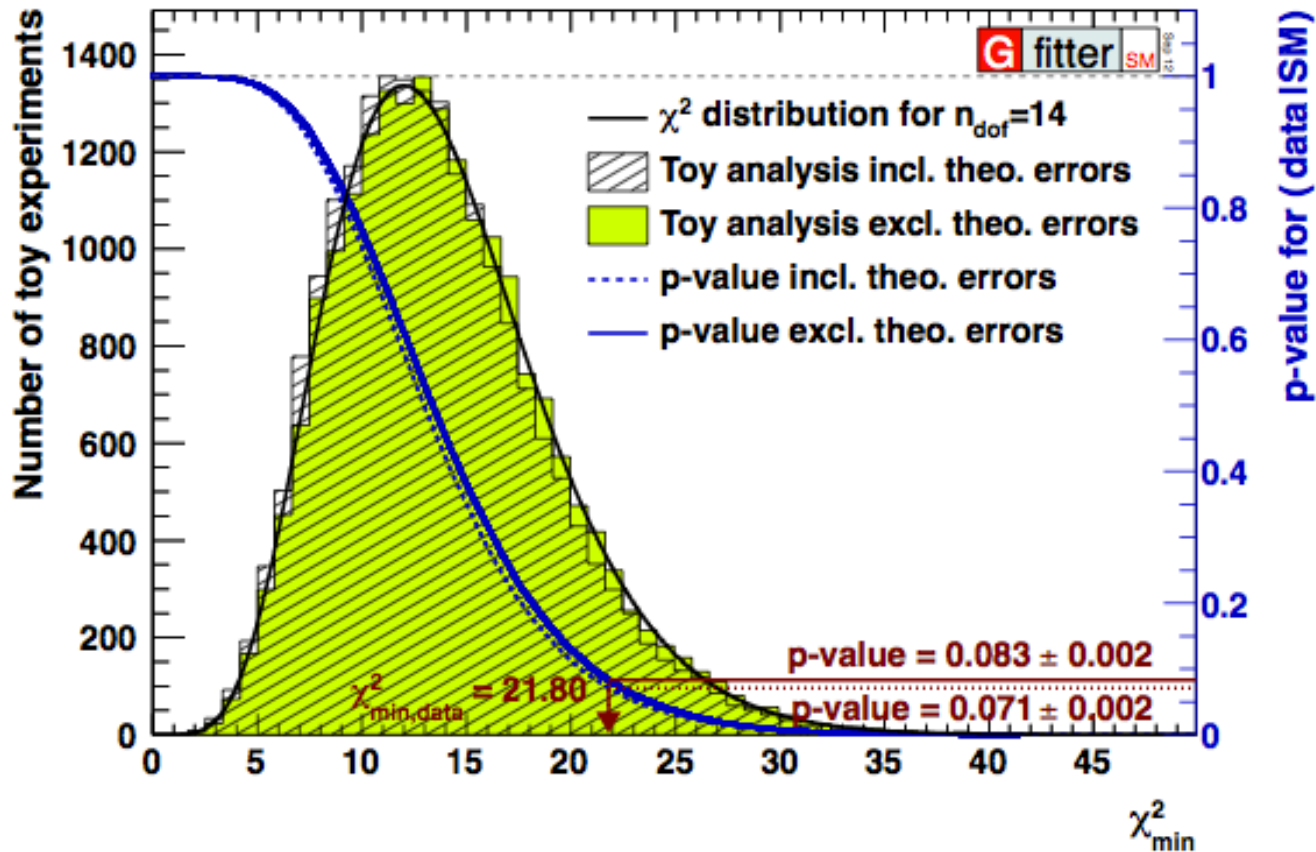



- At low energies, BSM physics appears dominantly through vacuum polarization corrections
 - Aka, “oblique corrections”
- Oblique corrections reabsorbed into electroweak parameters
 - $\Delta\rho$, $\Delta\kappa$, Δr parameters, appearing in: M_W^2 , $\sin^2\theta_{\text{eff}}$, G_F , α , etc
- Electroweak fit sensitive to BSM physics through oblique corrections
 - In direct competition with sensitivity to Higgs loop corrections

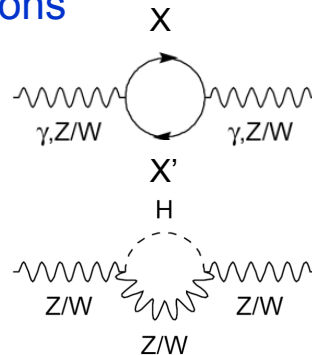

- Oblique corrections from New Physics described through STU parametrization [Peskin and Takeuchi, Phys. Rev. D46, 1 (1991)]

$$O_{\text{meas}} = O_{\text{SM,REF}}(m_H, m_t) + c_S S + c_T T + c_U U$$

- S : New Physics contributions to neutral currents
- T : Difference between neutral and charged current processes – sensitive to weak isospin violation
- U : (+S) New Physics contributions to charged currents. U only sensitive to W mass and width, usually very small in NP models (often: U=0)

- Also implemented: correction to $Z \rightarrow b\bar{b}$ coupling, extended parameters (VWX)

[Burgess et al., Phys. Lett. B326, 276 (1994)]
 [Burgess et al., Phys. Rev. D49, 6115 (1994)]

- The branching ratio R_b^0 : partial decay width of $Z \rightarrow bb$ to $Z \rightarrow qq$
- Freitas et al: full 2-loop calculation of $Z \rightarrow bb$
- Contribution of same terms as in the calculation of $\sin^2\theta_{\text{eff}}^{bb}$
→ cross-check of two results found good agreement
- Two-loop corrections comparable to experimental uncertainty (6.6×10^{-4})

M_H [GeV]	1-loop EW and QCD correction to FSR $\mathcal{O}(\alpha) + \text{FSR}_{1\text{-loop}}$ [10^{-3}]	2-loop EW correction $\mathcal{O}(\alpha_{\text{ferm}}^2)$ [10^{-4}]	2-loop EW and 2+3-loop QCD correction to FSR $\mathcal{O}(\alpha_{\text{ferm}}^2) + \text{FSR}_{>1\text{-loop}}$ [10^{-4}]	1+2-loop QCD correction to gauge boson self-energies $\mathcal{O}(\alpha\alpha_s, \alpha\alpha_s^2)$ [10^{-4}]
100	-3.632	-6.569	-9.333	-0.404
200	-3.651	-6.573	-9.332	-0.404
400	-3.675	-6.581	-9.331	-0.404

- Determination of α_s at N3LO.
- Most sensitive through total hadronic cross-section σ_{had}^0 and partial leptonic width R_l^0
- Theory uncertainty obtained by scale variation, at per-mille level.

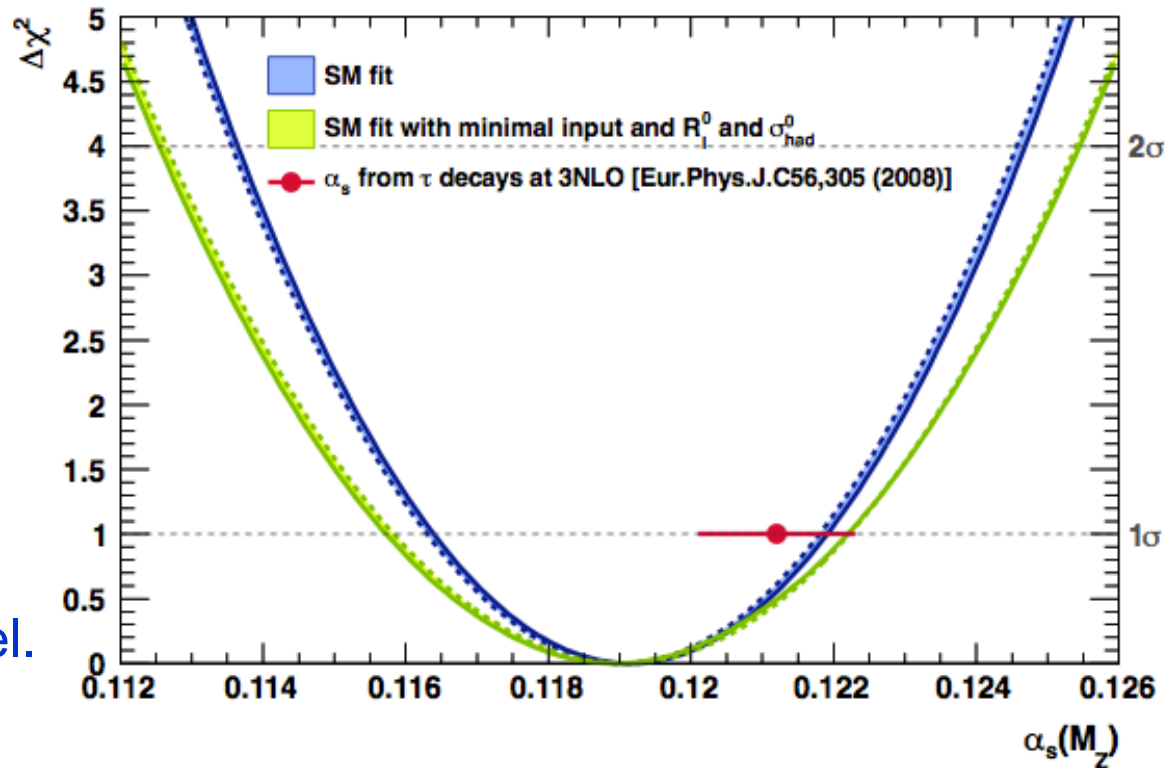

$$\alpha_s(M_Z) = 0.1191 \pm 0.0028 \text{ (exp.)} \pm 0.0001 \text{ (theo.)}$$

- Good agreement with value from t decays, also at N3LO.
- Improvements in precision only expected with ILC/GigaZ

Higgs couplings in the EW fit



- In latest ATLAS $H \rightarrow \gamma\gamma$, 2.3σ deviation seen from SM μ ($\equiv 1.0$)
- Interpret.: $H \rightarrow VV$ couplings scaled with c_V

From: Falkowski et al, arXiv:1303.1812

- Modified Higgs couplings can be constrained by EW fit through extended STU formalism.
- Result of c_V driven by limit on T parameter.

• Tree-level relation:
$$\rho_0 = \frac{M_{W_0}^2}{M_{Z_0}^2 c_W^2} = 1 + \alpha T$$

•
$$\alpha T \approx \frac{3g_Y^2}{32\pi^2} (c_V^2 - 1) \log(\Lambda/m_Z)$$

- Reminder: $T = 0.05 \pm 0.12$ (Gfitter)
- EW-fit Falkowski et al: $c_V \approx 1.08 \pm 0.07$
- Blue dashed: c_V from μ 's, black: comb. w/ EW

